

Note: Electrical requirements are 8 Amps / 115 Volts/ 60Hz/ 3 Pole GFI Receptacle.

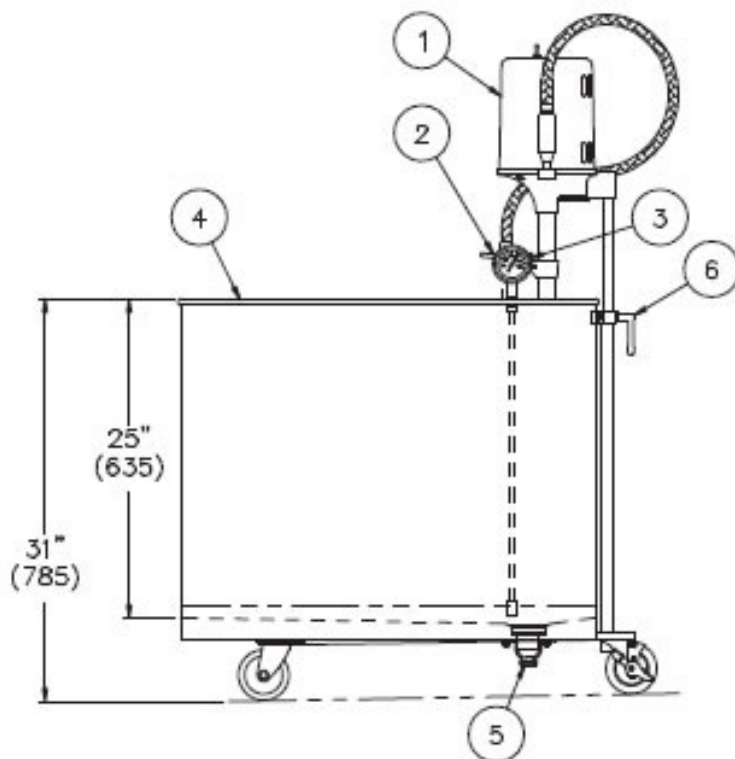

All dimension figures
in parentheses are in
millimeters.

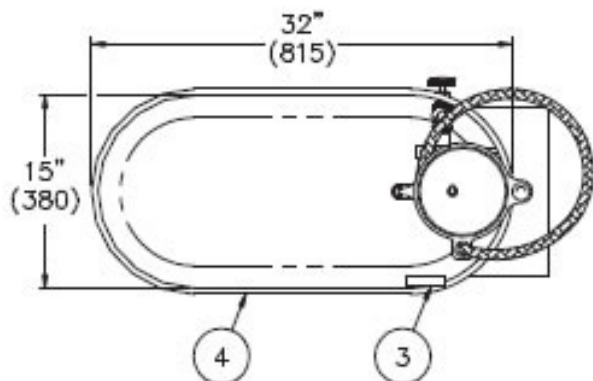

MOBILE E-45-M SERIES WHIRLPOOL

NOTES:

1. 1/2 hp Jet Pump Motor.
2. Variable Pressure Control.
3. Thermometer.
4. Stainless Steel Tank.

5. Auxiliary Drain Valve.
6. Turbine Raising & Lowering Device.